

E1EX-D

Ex db IIC, Ex eb IIC, Ex tb IIIC, Ex nR IIC

CAPTIVE COMPONENT GLAND WITH DELUGE SEAL for Multi Armoured Cable



Features and Benefits

- For indoors, outdoors, Group II, III, Zone 1, 2, 21 and 22 hazardous areas.
- Two part handling, no loose parts.
- Freely rotating captive cone and inspectible cone ring provides an armour clamp and earth bond on steel wire, aluminium, braid and tape armour.
- Patented disconnect system that allows inspection of armour clamp and inner seal after assembly.
- With an internal deluge seal as standard.
- Factory fitted with a specially formulated elastomeric seal for Built-in Safety™, seals on the inner and outer sheath of the cable to IP65/66/68.
- Precision manufactured from high quality Brass (Marine Grade™ Electroless Nickel Plated) or Stainless Steel 316/316L
- Complete with thread sealing gasket.



Technical Data

Type:	E1EX-D	
Gland Material:	Brass (Marine Grade™ Electroless Nickel Plated) or Stainless Steel 316/316L	
Seal Material:	Standard Thermoset Elastomer or Extreme Temperature Seals	
Cable Type:	Steel Wire, Aluminium, Braided and Tape Armour	
Armour Clamping:	Rotating Captive Cone and Inspectible Cone Ring	
Sealing Area:	Inner Sheath, Outer Sheath and Deluge Seal	
Optional Accessories:	Adaptor, Reducer, Earth Tag, Locknut, Serrated Washer and Shroud Note: The installer should ensure that the materials are suitable for the installation environment.	

Standards and Certifications

Equipment Protection Levels:	IECEX: Ex db IIC Gb, Ex eb IIC Gb, Ex nR IIC Gc, Ex tb IIIC Db ATEX: Ⓜ II 2GD, II 3G, Ex db IIC Gb, Ex eb IIC Gb, Ex nR IIC Gc, Ex tb IIIC Db	
Operating Temperature:	-20°C to +95°C Standard Seals or -60°C to 160°C Extreme Temp. Seals (continuous)	
Conformance:	Standard:	Certificate:
IEC/BS EN	IEC/BS EN 62444, 6121	
IECEX	IEC 60079 Parts 0, 1, 7, 15, 31	IEC Ex CML 18.0018X
ATEX	EN 60079 Parts 0, 1, 7 and 31 EN 60079 Parts 0 and 15	CML 16ATEX1001X CML 16ATEX4002X
IP66/68 100m - Parallel	IEC 60529	IEC Ex CML 18.0018X
IP65/66 - Tapered	IEC 60529	
Deluge Protection	DTS-01	CML 14CA370-2
Corrosion Protection	ASTM B117-11, BS EN ISO 3231	EXOVA N968667
EMC Compatible	EN 55011:2009 + A1:2010, EN 55022:2010	

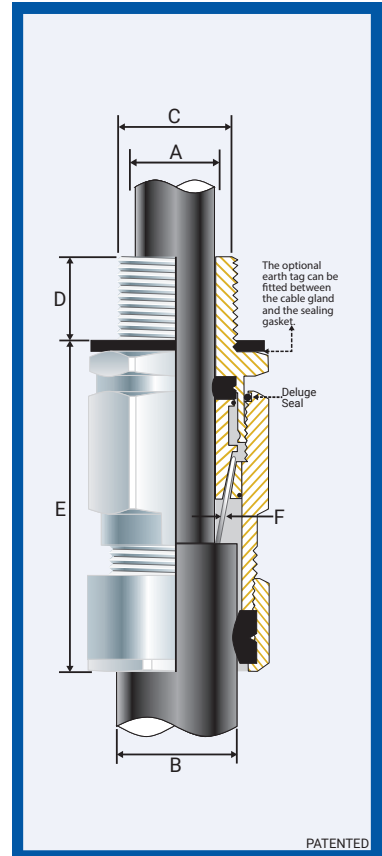

Conditions for Safe Use - X

- The cable glands shall only be used where the temperature, at the point of entry, is between -20°C and +95°C (standard seal) or -60°C to 160°C (extreme temp. seal) depending on seal and gasket used.
- **According to IEC 60079-14, 10.6.2: The Ex d gland will only maintain Ex d integrity when used with substantially round, compact and filled cable. If not a CCG E1EX-D QuickStop-Ex™ barrier gland should be used.**
- Braided cables must only be used on fixed installations where the cable is clamped or stress applied to the cable in the gland is prevented.

Product Code	Gland Size Reference	Metric Entry Thread		NPT Entry Thread		Cable Detail				Max Length 'E'	Armour Dia		Hexagonal Detail		Install. Torque Value Nm	
		'C'	Min 'D'	'C'	Min 'D'	Min 'A'	Max 'A'	Min 'B'	Max 'B'		Min 'F'	Max 'F'	Max 'Flats'	Max 'Crns'		
055400S-16	00s-16ss	M16x1.5	12	-	-	3.0	8.5	5.0	10.5	74.0	0.2	0.9	24.0	27.0	21.0	
055400S	00s-20ss	M20x1.5	12	1/2	3/4	15	3.0	8.5	5.0	10.5	74.0	0.2	0.9	24.0	27.0	21.0
055400	00-20ss	M20x1.5	12	1/2	3/4	15	3.0	8.5	8.0	14.0	73.0	0.2	0.9	24.0	27.0	21.0
0554-0S-16	0s-16s	M16x1.5	12	-	-	7.0	12.0	8.0	14.0	70.0	0.2	1.25	24.0	27.0	21.0	
0554-0S	0s-20s	M20x1.5	12	1/2	3/4	15	7.0	12.0	8.0	14.0	70.0	0.2	1.25	24.0	27.0	21.0
0554-0	0-20s	M20x1.5	12	1/2	3/4	15	7.0	12.0	11.5	16.0	70.0	0.2	1.25	24.0	27.0	21.0
055401	1-20	M20x1.5	12	1/2	3/4	15	9.0	15.0	12.5	20.5	83.0	0.2	1.25	27.0	30.0	21.0
055422	2s-25s	M25x1.5	12	3/4	1	15/19	11.0	17.5	16.0	24.5	96.0	0.2	1.60	35.0	39.0	30.0
055402	2-25	M25x1.5	12	3/4	1	15/19	14.0	20.0	18.0	27.0	96.0	0.2	1.60	35.0	39.0	30.0
055433	3s-32s	M32x1.5	12	1	1 1/4	19	15.0	22.0	20.0	30.5	111.0	0.2	2.00	42.0	47.0	42.0
055403	3-32	M32x1.5	12	1	1 1/4	19	19.0	26.5	23.0	33.5	111.0	0.2	2.00	42.0	47.0	42.0
055444	4s-40s	M40x1.5	12	1 1/4	1 1/2	19/21	22.0	31.5	26.5	39.0	112.0	0.3	2.00	52.0	59.0	52.0
055404	4-40	M40x1.5	12	1 1/4	1 1/2	19/21	26.0	34.0	28.0	40.0	117.0	0.3	2.00	52.0	59.0	52.0
055455	5s-50s	M50x1.5	12	1 1/2	2	21	29.0	38.0	35.2	47.5	131.0	0.4	2.50	65.0	73.0	57.0
055405	5-50	M50x1.5	12	1 1/2	2	21	34.0	44.5	44.4	52.8	136.0	0.4	2.50	65.0	73.0	57.0
055466	6s-63s	M63x1.5	12	2	2 1/2	21/30	38.0	50.0	45.5	60.5	148.0	0.4	2.50	80.0	90.0	66.0
055406	6-63	M63x1.5	12	2	2 1/2	21/30	44.0	56.5	54.6	65.9	148.0	0.4	2.50	80.0	90.0	66.0
055477	7s-75s	M75x1.5	12	2 1/2	3	30/32	50.0	62.0	59.0	72.5	174.0	0.4	3.15	96.0	108.0	72.0
055407	7-75	M75x1.5	12	2 1/2	3	30/32	56.0	67.5	65.0	78.0	173.0	0.4	3.15	96.0	108.0	72.0
055408	8-80	M80x2.0	16	3	3	32	59.0	69.0	65.0	77.5	166.0	0.4	3.15	96.0	108.0	80.0
055499	9s-90s	M90x2.0	16	3	3 1/2	32/33	66.0	75.0	73.0	86.5	185.0	0.4	3.50	111.0	125.0	89.0
055409	9-90	M90x2.0	16	3	3 1/2	32/33	74.0	81.5	82.0	91.0	185.0	0.4	3.50	111.0	125.0	89.0
055410	10-100	M100x2.0	16	3 1/2	4	33/34	81.0	91.0	90.0	100.0	204.0	0.4	3.50	125.0	141.0	98.0

All dimensions except NPT are in mm.

CCG reserves the right to make alterations to the technical data, dimensions, designs and products available without notice. The illustrations cannot be considered binding. Please contact CCG for assistance.

E1EX-D-GH020818E

E1EX-D GLAND Ex db IIC, Ex eb IIC, Ex tb IIC, Ex nR IIC

ENCLOSURES AND EQUIPMENT TO WHICH CABLE GLANDS ARE FITTED:-

- Must be made from materials which are compatible with the cable gland materials.
- Have a sealing area around the cable gland entry point with a surface roughness < Ra 6.3 µm.
- Have entries that are perpendicular to the enclosure face in the area where the cable gland will seal to within 2.5°.
- Are sealed using the supplied sealing gasket (parallel threads) or by fully tightening into a threaded entry (tapered threads). Note that for tapered threads the IP rating can be improved to IP68 with the use of a suitable thread sealant.

MUST HAVE THREADED ENTRIES

- The same thread size as the cable gland. (Thread adapters should be used to correct

any mismatch).

- With a thread tolerance of metric class '6H' or equivalent.
- Where the thread length is a minimum of 10mm for Ex d applications or 3mm for all other applications

OR CLEARANCE HOLES (not Ex d)

- Where the hole size is the thread nominal size with a tolerance of +0.1 to +0.7mm. (e.g. the clearance hole for an M20 thread will have a diameter between 20.1mm and 20.7mm).
- Through material that is between 1mm and 12mm thick. (Thicker materials can be accommodated using glands with extended entry threads.)

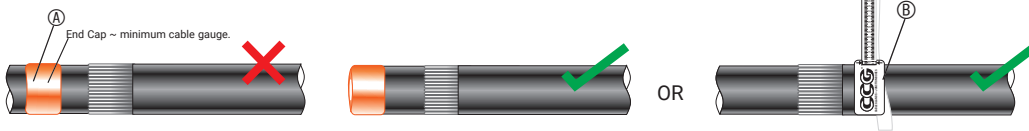

1. Check the correct gland size using an end cap (patented) ①. If the cable inner sheath passes through the hole in the end cap ①, use a gland one size smaller. For accurate sizing, use a CCG Dimension Tape ② on the inner and outer cable sheath.

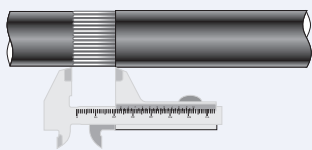

Gland Size	Armour Length	Gland Size	Armour Length	Gland Size	Armour Length	Gland Size	Armour Length
00-16ss	20.0	3s-32s	30.0	6s-63s	45.0	9-90	50.0
00-20ss	20.0	3-32	30.0	6-63	45.0	10-100	60.0
0-20s	20.0	4s-40s	30.0	7s-75s	50.0	11-115	60.0
1-20	25.0	4-40	30.0	7-75	50.0	12-120	60.0
2s-25s	25.0	5s-50s	35.0	8-80	50.0	13-130	60.0
2-25	25.0	5-50	35.0	9s-90s	50.0		

2. Cut back the cable outer sheath to expose the armour to a length as per the table above.

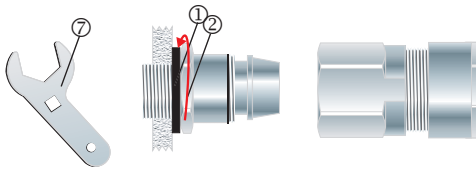

3. To maintain IP66/68 ensure the gasket ① is in place. Screw the inner ② into the apparatus. Tighten the inner ② to the installation torque using a CCG Spanner ⑦.

Alternative installation through an unthreaded entry.

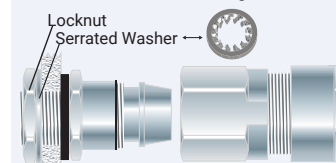

If the apparatus is untapped use a locknut.

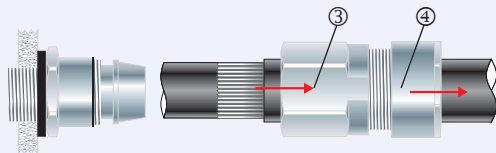

4. Pass the outer nut ④ and the body ③ over the cable.

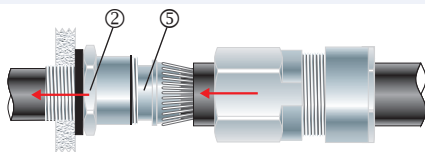

5. Pass the cable end through the inner ②. Splay the armour wires over the cone ⑤.

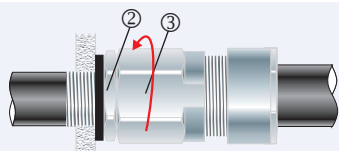

6. Tighten the body ③ onto the inner ② to lock the armour between the cone ⑤ and cone ring ⑥. The deluge seal will engage automatically as the body is tightened onto the inner ②.

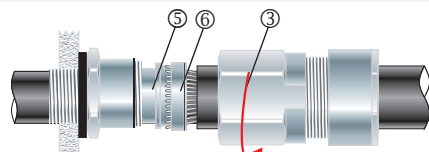

7. Unscrew the body ③. Check that the armour has locked between the cone ⑤ and cone ring ⑥. (O-Ring on the cone ring ⑥ is sacrificial).

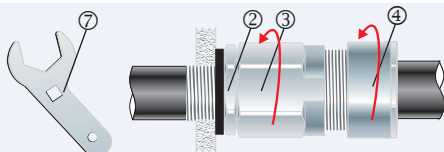

8. Tighten the body ③ onto the inner ② to the installation torque using a CCG Spanner ⑦. Tighten the outer nut ④ to produce a moisture proof seal by turning until the seal makes contact with the outer sheath of cable and then make one full turn.